

iSnake

Intelligent Multiplayer Snake





What is iSnake?

- is the variant of snake game popular among cell phone users





Features of iSnake

- Multi player feature
- Computer controlled intelligent opponents

Multiplayer

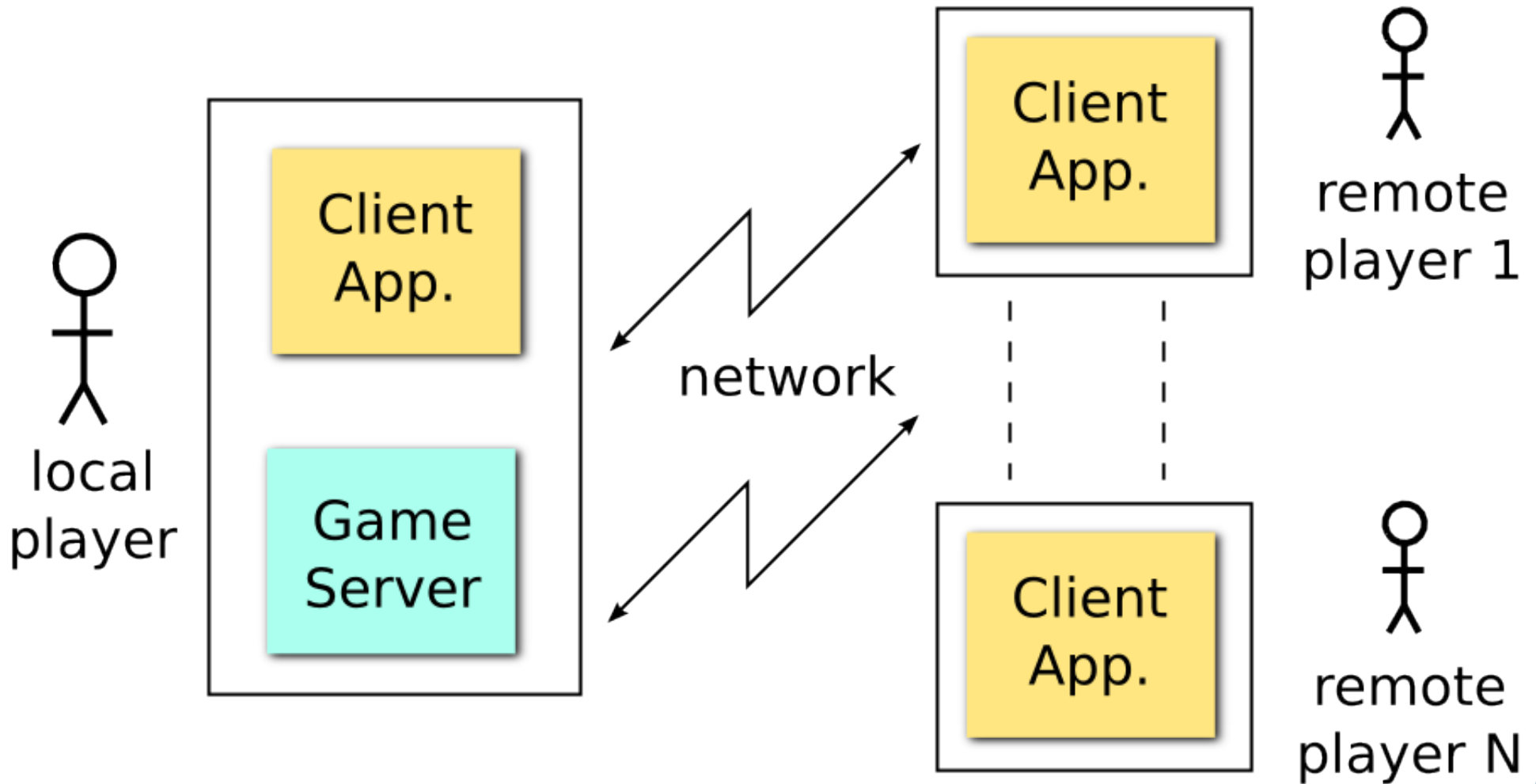



iSnake Client App.

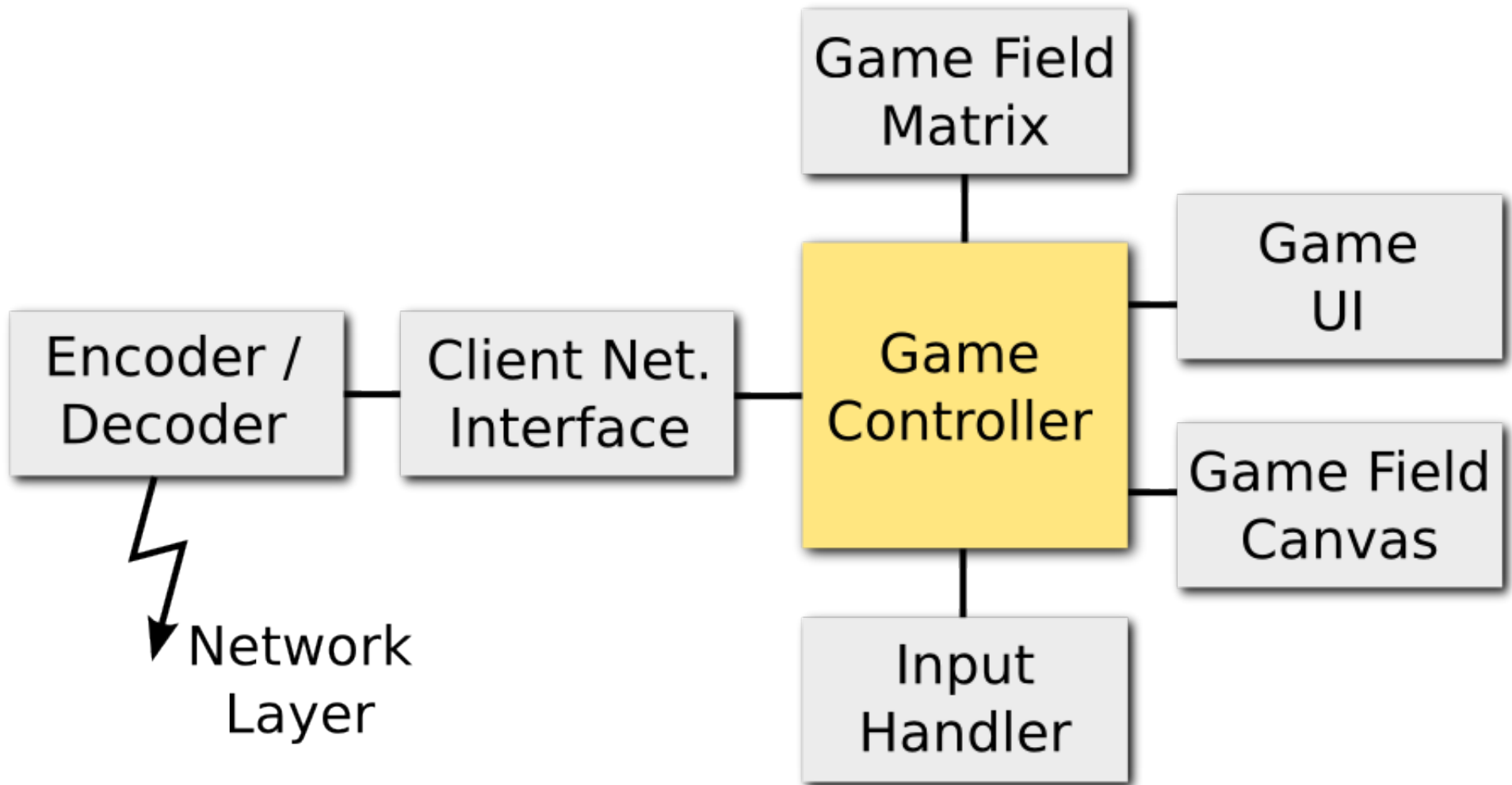



iSnake Game Server

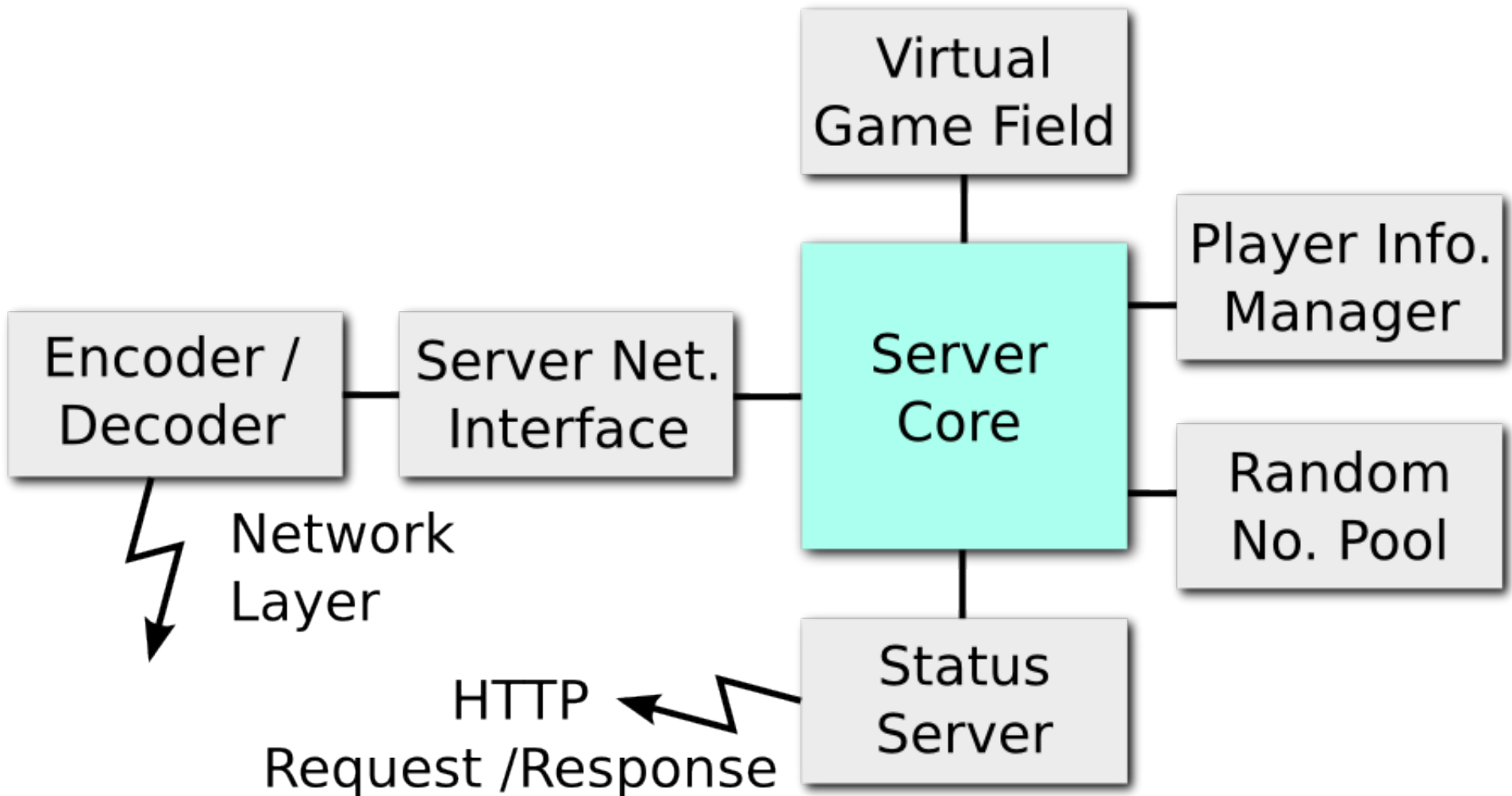



Features of iSnake

- ✓ Multi player feature
- Computer controlled intelligent opponents



Intelligent Opponents

- Two path finding algorithms have been developed:
 - Blackmamba
 - Viper
- The Input Handler of iSnake Client Application is replaced by the module implementing Blackmamba or Viper



Intelligent Opponents

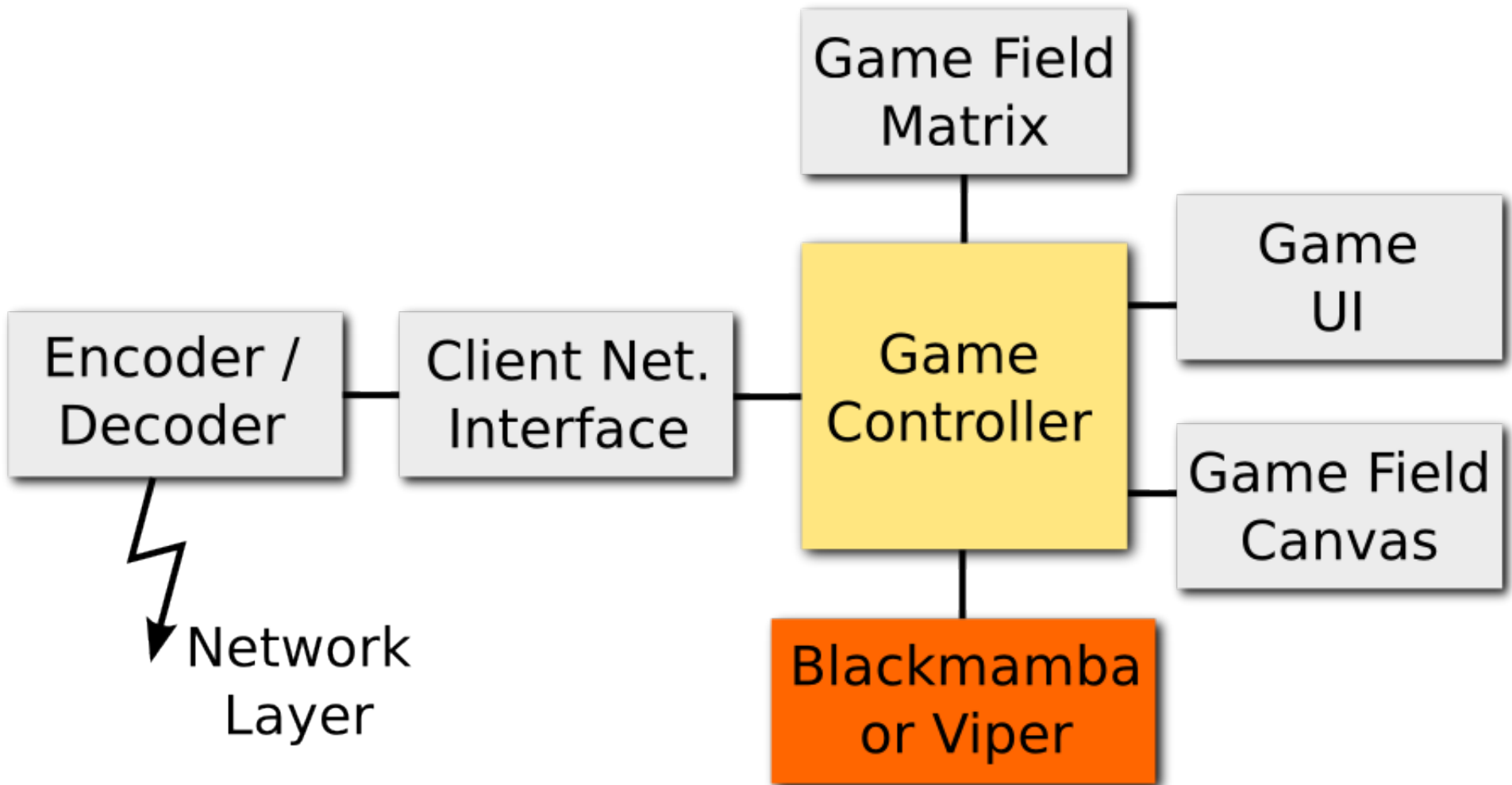



Intelligent Opponents

Turn Around Time

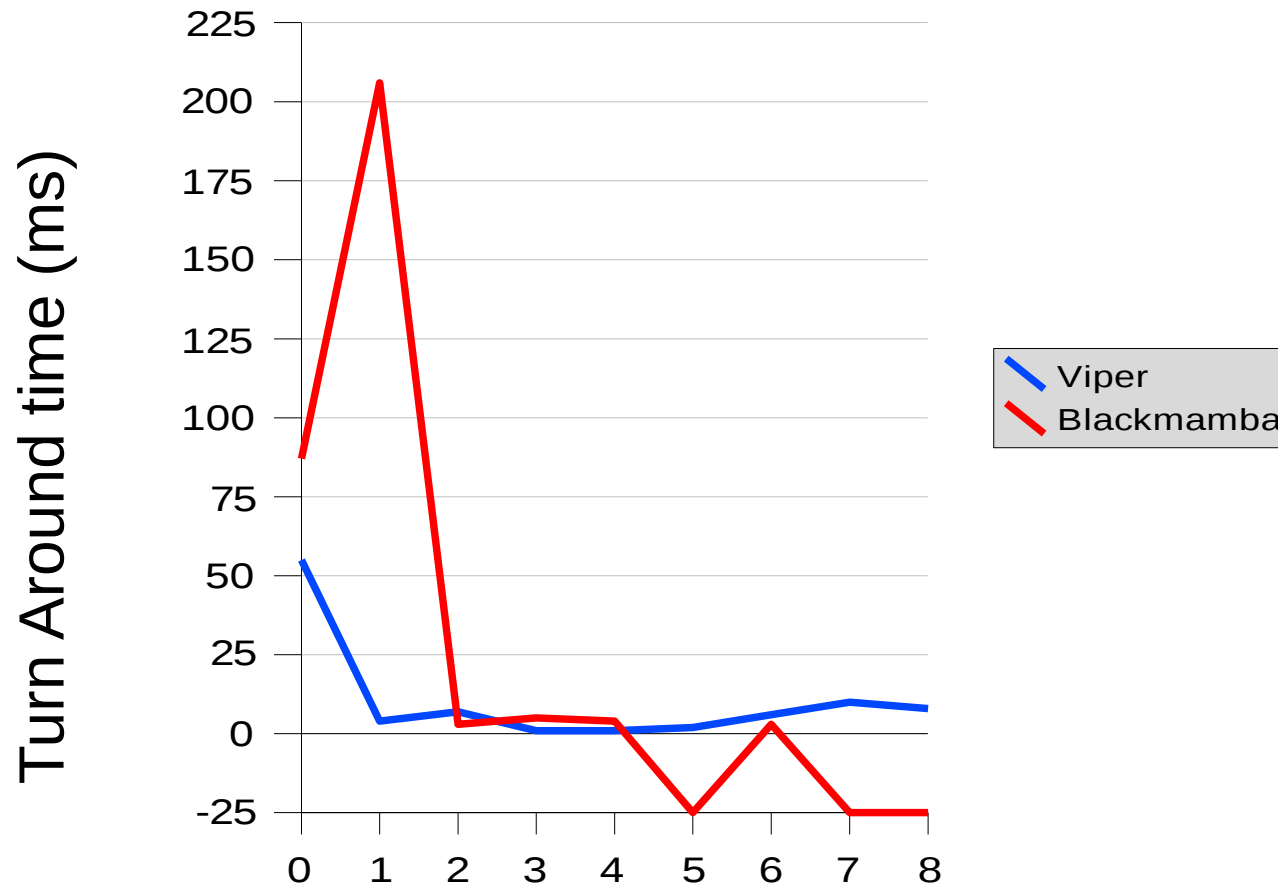

(Source, Target) coordinate pair id



Intelligent Opponents

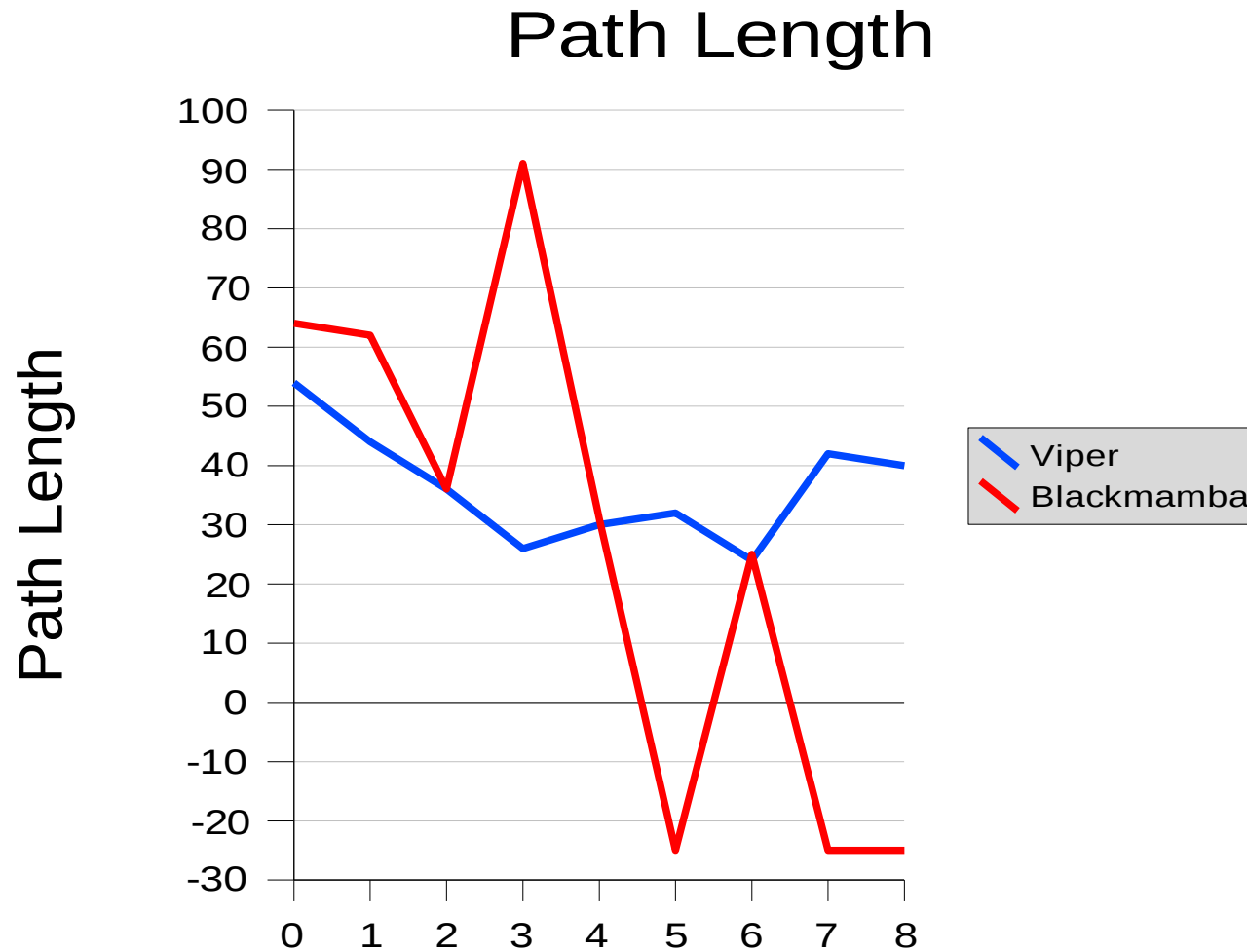

(Source, Target) coordinate pair id



Features of iSnake

- ✓ Multi player feature
- ✓ Computer controlled intelligent opponents



Game Server Manager

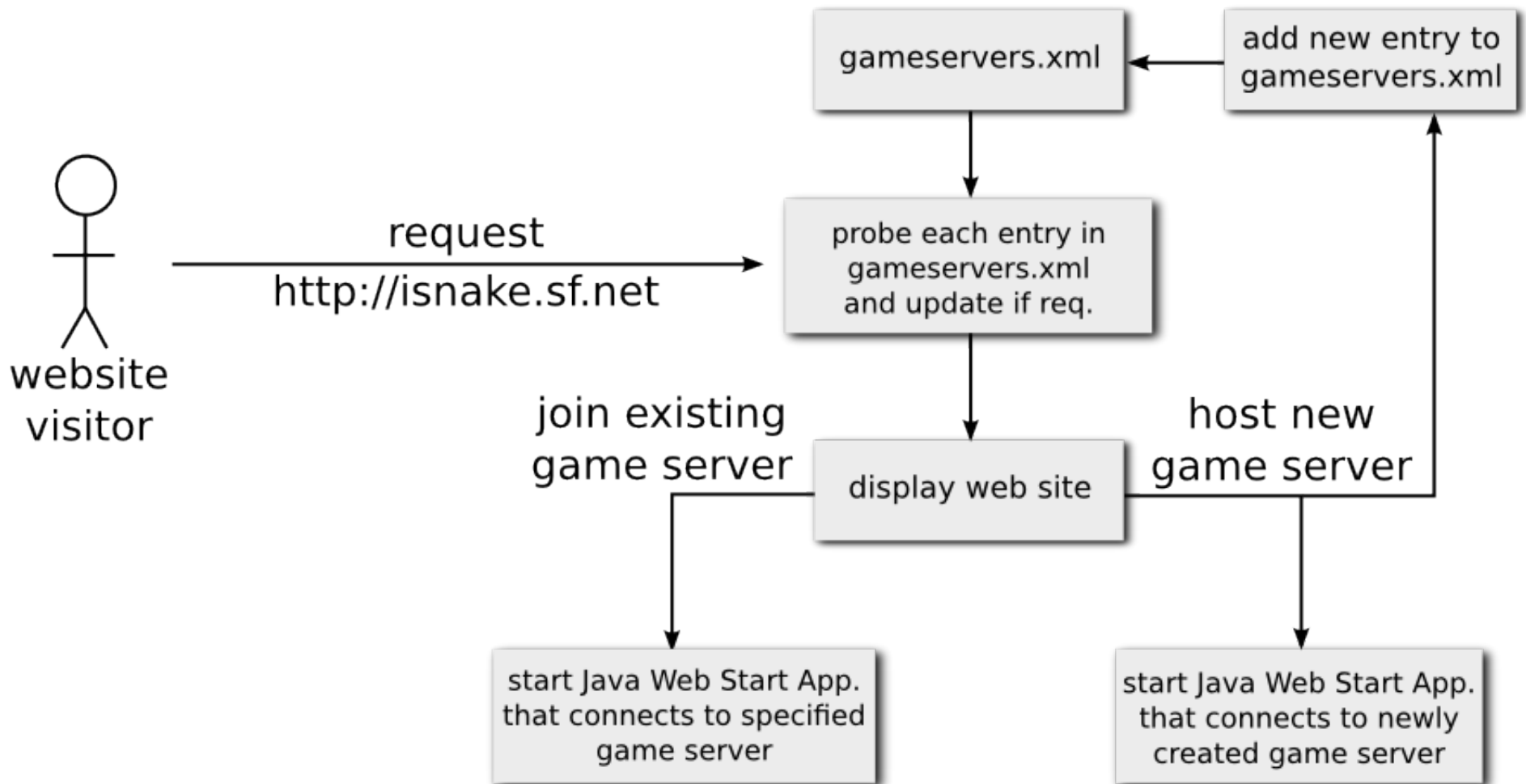



Documentation

- Source code contains full code documentation conforming to Javadoc standards.
- Both path finding algorithms have been fully documented with illustrations.
- The protocol devised for communication between game server and clients has also been documented.
- All documents available at iSnake's Doc. Repo.
<http://isnake.sf.net/docs>



Project Management

- iSnake code managed using subversion – a version control system
- Collaboration on project docs (prototype design, project plan, TODO list, etc) done using WIKI
- Junit tests were developed to test modules before integration
- All the project management resources were provided by sourceforge.



Why Snake game?

Simplicity !





<http://isnake.sourceforge.net>

Thank You